



## Main

Range of product	Zelio Time
Product or component type	Modular timing relay
Discrete output type	Relay
Width	0.69 in (17.5 mm)
Device short name	RE17R
Time delay type	C A B At D Ht Bw Di H Ac
Time delay range	6...60 min 1...10 h 0.1...1 s 1...10 s 1...10 min 10...100 h 6...60 s
Nominal output current	8 A

## Complementary

Contacts type and composition	1 C/O
Contacts material	Cadmium free
Height	3.54 in (90 mm)
Depth	2.83 in (72 mm)

\* Price is "List Price" and may be subject to a trade discount – check with your local distributor or retailer for actual price.

Control type	Selector switch front panel
[Us] rated supply voltage	24...240 V AC 50/60 Hz 24 V DC
Voltage range	0.85...1.1 Us
Supply frequency	50...60 Hz +/- 5 %
Release of input voltage	10 V
Connections - terminals	Screw terminals, 1 x 0.5...1 x 3.3 mm <sup>2</sup> AWG 20...AWG 12) solid without cable end Screw terminals, 2 x 0.5...2 x 2.5 mm <sup>2</sup> AWG 20...AWG 14) solid without cable end Screw terminals, 1 x 0.2...1 x 2.5 mm <sup>2</sup> AWG 24...AWG 14) flexible with cable end Screw terminals, 2 x 0.2...2 x 1.5 mm <sup>2</sup> AWG 24...AWG 16) flexible with cable end
Tightening torque	5.31...8.85 lbf.in (0.6...1 N.m) IEC 60947-1
Housing material	Self-extinguishing
Repeat accuracy	+/- 0.5 % IEC 61812-1
Temperature drift	+/- 0.05 %/°C
Voltage drift	+/- 0.2 %/V
Setting accuracy of time delay	+/- 10 % of full scale 25 °C IEC 61812-1
Control signal pulse width	100 ms with load in parallel typical 30 ms typical
Insulation resistance	100 MOhm 500 V DC IEC 60664-1
Reset time	120 ms on de-energisation typical
On-load factor	100 %
Power consumption in VA	0...32 VA 240 V AC
Maximum power consumption in W	0.6 W 24 V DC
Minimum switching current	10 mA 5 V DC
Maximum switching current	8 A AC/DC
Maximum switching voltage	250 V AC
Breaking capacity	2000 VA
Operating frequency	10 Hz
Electrical durability	100000 cycles resistive 8 A 250 V AC
Mechanical durability	10000000 cycles
Dielectric strength	2.5 kV 1 mA/1 minute 50 Hz IEC 61812-1
[Uimp] rated impulse withstand voltage	5 kV 1.2/50 µs
Power on delay	100 ms
Marking	CE
Creepage distance	4 kV/3 IEC 60664-1
Safety reliability data	B10d = 270000 MTTFd = 296.8 years
Mounting position	Any position in relation to normal vertical mounting plane
Mounting support	35 mm DIN rail EN/IEC 60715
Local signalling	LED indicator on steady: relay energised, no timing in progress LED indicator 80 % ON and 20 % OFF flashing: timing in progress LED indicator 5 % ON and 95 % OFF pulsing: relay de-energised, no timing in progress (except function Di-D, Li-L)
Net Weight	0.15 lb(US) (0.07 kg)
Time delay type	A, Ac, At, B, Bw, C, D, Di, H, Ht
Functionality	Multifunction
Compatibility code	RE17

## Environment

Immunity to microbreaks	20 ms
Standards	2006/95/EC 2004/108/EC IEC 61812-1 EN 61000-6-2 EN 61000-6-3 EN 61000-6-4 EN 61000-6-1

Product certifications	CSA GL CULus
Ambient air temperature for storage	-22...140 °F (-30...60 °C)
Ambient air temperature for operation	-4...140 °F (-20...60 °C)
IP degree of protection	IP20 IEC 60529 terminal block) IP40 IEC 60529 housing) IP50 IEC 60529 front panel)
Vibration resistance	20 m/s <sup>2</sup> 10...150 Hz)IEC 60068-2-6
Shock resistance	15 gn 11 ms IEC 60068-2-27
Relative humidity	93 % without condensation IEC 60068-2-30
Electromagnetic compatibility	Electrostatic discharge immunity test 6 kV in contact) level 3 IEC 61000-4-2 Electrostatic discharge immunity test 8 kV in air) level 3 IEC 61000-4-2 Susceptibility to electromagnetic fields 10 V/m 80 MHz to 1 GHz) level 3 IEC 61000-4-3 Electrical fast transient/burst immunity test 1 kV capacitive connecting clip) level 3 IEC 61000-4-4 Electrical fast transient/burst immunity test 2 kV direct) level 3 IEC 61000-4-4 1.2/50 µs shock waves immunity test 1 kV differential mode) level 3 IEC 61000-4-5 1.2/50 µs shock waves immunity test 2 kV common mode) level 3 IEC 61000-4-5 Conducted RF disturbances 10 V 0.15...80 MHz) level 3 IEC 61000-4-6 Voltage dips and interruptions immunity test 0 % 1 cycle) IEC 61000-4-11 Voltage dips and interruptions immunity test 70 % 25/30 cycles) IEC 61000-4-11 Conducted and radiated emissionsclass B EN 55022

### Ordering and shipping details

Category	22370 - RE, RM MISC TIMERS & COUNTERS
Discount Schedule	CP2
GTIN	00785901543633
Nbr. of units in pkg.	1
Package weight(Lbs)	0.17 lb(US) (0.08 kg)
Returnability	Yes
Country of origin	ID

### Packing Units

Unit Type of Package 1	PCE
Package 1 Height	1.02 in (2.6 cm)
Package 1 width	3.07 in (7.8 cm)
Package 1 Length	3.74 in (9.5 cm)
Package 2 Weight	8.41 lb(US) (3.813 kg)
Package 3 Weight	144.84 lb(US) (65.7 kg)

### Offer Sustainability

Sustainable offer status	Green Premium product
California proposition 65	WARNING: This product can expose you to chemicals including: Lead and lead compounds, which is known to the State of California to cause cancer and birth defects or other reproductive harm. For more information go to <a href="http://www.P65Warnings.ca.gov">www.P65Warnings.ca.gov</a>
REACH Regulation	<a href="#">REACH Declaration</a>
EU RoHS Directive	Pro-active compliance (Product out of EU RoHS legal scope) <a href="#">EU RoHS Declaration</a>
Mercury free	Yes
RoHS exemption information	<a href="#">Yes</a>
China RoHS Regulation	<a href="#">China RoHS declaration</a>
Environmental Disclosure	<a href="#">Product Environmental Profile</a>
Circularity Profile	<a href="#">End of Life Information</a>

Width 17.5 mm

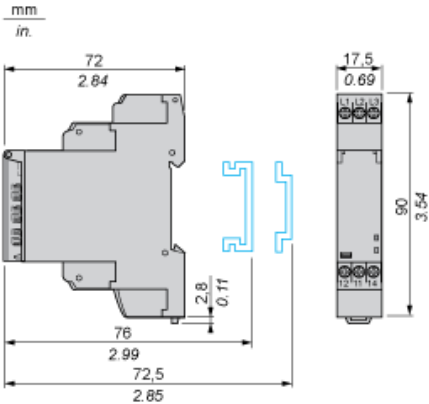

## Internal Wiring Diagram

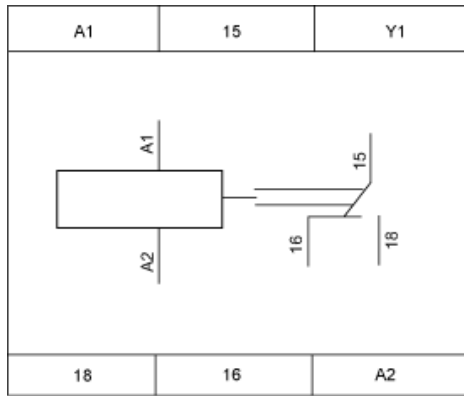

---

Wiring Diagram

---

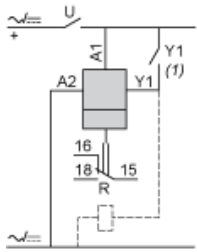

1) Contact Y1:

- Control for functions B, C, Ac, Bw, Ad, Ah, N, O, W, T, Tt.
- Partial stop for functions At, Ht and Pt.
- Function D if Di selected.
- Not used for functions A, H and P.

---

Function A : Power on Delay Relay

---

Description

The timing period T begins on energisation. After timing, the output(s) R close(s). The second output can be either timed or instantaneous.

Function: 1 Output



Function: 2 Outputs

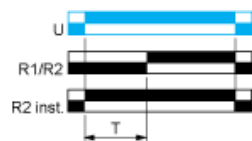

2 timed outputs (R1/R2) or 1 timed output (R1) and 1 instantaneous output (R2 inst.)

---

Function Ac: On-Delay & Off-Delay with Control Signal

---

Description

After energisation of power supply and energization of Y1 causes the timing period T to start.

At the end of this timing period, the output(s) R close(s).

When deenergization of Y1, the timing T starts.

At the end of this timing period T, the output(s) R revert(s) to its/their initial position.

The second output (R2) can be either timed (when set to "TIMED") or instantaneous (when set to "INST").

Function: 1 Output



Function: 2 Outputs

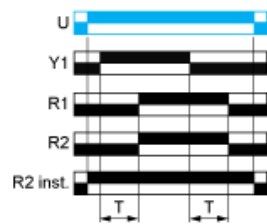

---

Function At : Power on Delay Relay (Summation) with Control Signal

---

Description

After power-up, the first opening of control contact C starts the timing. Timing can be interrupted each time control contact closes. When the cumulative total of time periods elapsed reaches the pre-set value T, the output relay closes.

Function: 1 Output

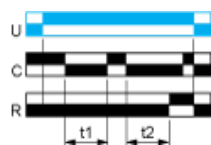

$T = t1 + t2 + \dots$

---

Function B : Interval Relay with Control Signal

---

Description

After power-up, pulsing or maintaining control contact C starts the timing T. The output R closes for the duration of the timing period T then reverts to its initial state.

Function: 1 Output

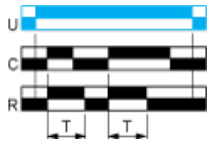

---

Function Bw : Double Interval Relay with Control Signal

---

Description

On closing and opening of control contact C, the output R closes for the duration of the timing period T.

Function: 1 Output

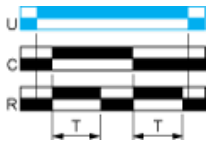

---

Function C : Off-Delay Relay with Control Signal

---

Description

After power-up and closing of the control contact C, the output R closes. When control contact C re-opens, timing T starts. At the end of the timing period, the output(s) R revert(s) to its/their initial state. The second output can be either timed or instantaneous.

Function: 1 Output

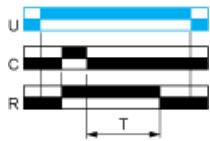

Function: 2 Outputs

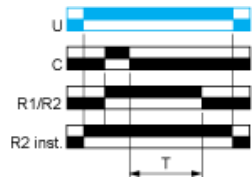

2 timed outputs (R1/R2) or 1 timed output (R1) and 1 instantaneous output (R2 inst.)

Function D: Symmetrical Flashing Relay (Starting Pulse Off)

Description

On energisation of power supply, output(s) R starts at its/their initial state for timing duration T then change(s) to output(s) R close(s) for the same timing duration T. This cycle is repeated indefinitely until power supply removal. Specially for RE17\*, RE22R2AMU, RE22R2MMW, RE22R2MMU, RE22R2MJU, this D function can only be initiated by energizing Y1 permanently. The second output (R2) can be either timed (when set to "TIMED") or instantaneous (when set to "INST").

Function: 1 Output



Function: 2 Outputs

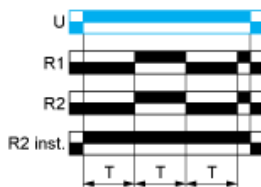

Function: 1 Output with Retrigger / Restart Control

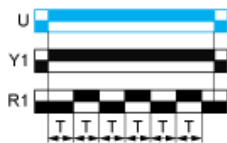

Function: 2 Output with Retrigger / Restart Control

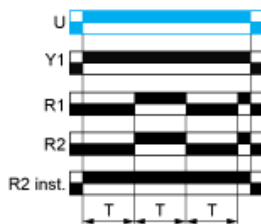

---

Function Di : Symmetrical Flasher Relay (Starting Pulse On)

---

Description

Repetitive cycle with two timing periods  $T$  of equal duration, with output(s)  $R$  changing state at the end of each timing period  $T$ .  
The second output can be either timed or instantaneous.

Function: 1 Output

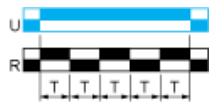

Function: 2 Outputs

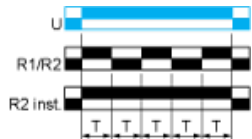

2 timed outputs (R1/R2) or 1 timed output (R1) and 1 instantaneous output (R2 inst.)

---

Function H : Interval Relay

---

Description

On energisation of the relay, timing period T starts and the output(s) R close(s). At the end of the timing period T, the output(s) R revert(s) to its/ their initial state. The second output can be either timed or instantaneous.

Function: 1 Output



Function: 2 Outputs

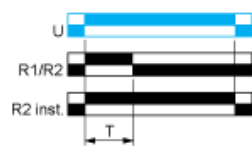

2 timed outputs (R1/R2) or 1 timed output (R1) and 1 instantaneous output (R2 inst.)

Function Ht: Interval Relay & With Pause / Summation Control

Description

On energisation of power supply, output(s) R close(s) and timing period T starts.

The timing can be interrupted / paused each time X1 energizes.

When the cumulative total of time periods elapsed reaches the pre-set value T, the output(s) R revert(s) to its/their initial state Reenergization of X1 will also cause output(s) R close(s) if the time has elapsed and restart the same operation as described at the beginning.

Except for RE17\*, RE22R2MMW, RENF22R2MMW, RE22R2MMU and RE22R2MJU, timing can be interrupted / paused each time Y1 energizes.

The second output (R2) can be either timed (when set to "TIMED") or instantaneous (when set to "INST").

Function: 1 Output

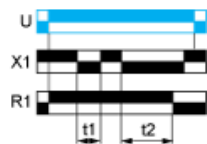

$$T = t1 + t2 + \dots$$

Function: 2 Outputs

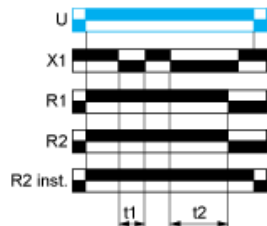

$$T = t1 + t2 + \dots$$

Function: 1 Output with Retrigger / Restart Control

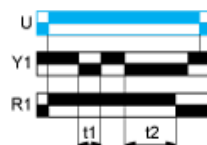

$$T = t1 + t2 + \dots$$

Function: 2 Outputs with Retrigger / Restart Control

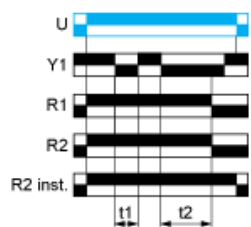

$$T = t1 + t2 + \dots$$

---

Legend

---

Relay de-energised

Relay energised

Output open

Output closed

C Control contact

G Gate

R Relay or solid state output

R1/R2 2 timed outputs

R2 inst. The second output is instantaneous if the right position is selected

T Timing period

Ta - Adjustable On-delay

Tr - Adjustable Off-delay

U Supply